

MC3361C

Low Power Narrowband FM IF

The MC3361C includes an Oscillator, Mixer, Limiting Amplifier, Quadrature Discriminator, Active Filter, Squelch, Scan Control and Mute Switch. This device is designed for use in FM dual conversion communications equipment.

- Operates from 2.0 to 8.0 V Supply
- Low Drain Current 2.8 mA Typical @ $V_{CC} = 4.0$ Vdc
- Excellent Sensitivity: Input Limiting Voltage –
– 3.0 dB = 2.6 μ V Typical
- Low Number of External Parts Required
- Operating Frequency Up to 60 MHz
- Full ESD Protection

LOW POWER NARROWBAND FM IF

SEMICONDUCTOR TECHNICAL DATA

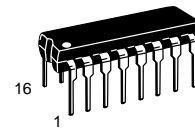

P SUFFIX
PLASTIC PACKAGE
CASE 648

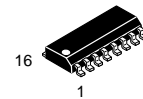

D SUFFIX
PLASTIC PACKAGE
CASE 751B
(SO-16)

Representative Block Diagram

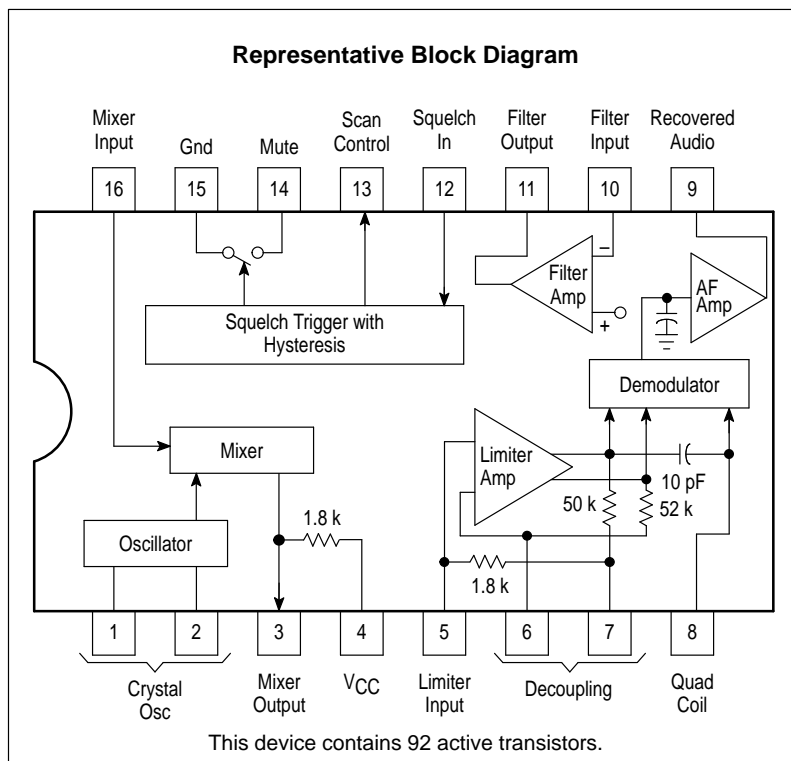

PIN CONNECTIONS

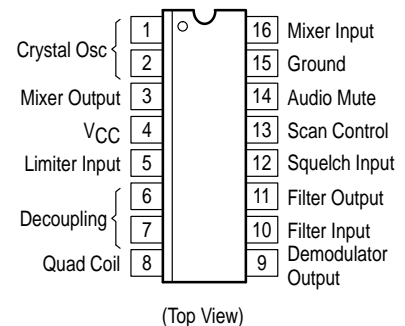

ORDERING INFORMATION

Device	Operating Temperature Range	Package
MC3361CD	$T_A = -30$ to $+70^\circ\text{C}$	SO-16
MC3361CP		Plastic DIP

MC3361C

MAXIMUM RATINGS (T_A = 25°C, unless otherwise noted.)

Rating	Pin	Symbol	Value	Unit
Power Supply Voltage	4	V _{CC(max)}	10	Vdc
Operating Supply Voltage Range	4	V _{CC}	2.0 to 8.0	Vdc
Detector Input Voltage	8	–	1.0	V _{p-p}
Input Voltage (V _{CC} ≥ 4.0 V)	16	V ₁₆	1.0	V _{RMS}
Mute Function	14	V ₁₄	–0.5 to +5.0	V _{pk}
Junction Temperature	–	T _J	150	°C
Operating Ambient Temperature Range	–	T _A	–30 to +70	°C
Storage Temperature Range	–	T _{stg}	–65 to +150	°C

ELECTRICAL CHARACTERISTICS (V_{CC} = 4.0 Vdc, f_o = 10.7 MHz, Δf = ± 3.0 kHz, f_{mod} = 1.0 kHz, T_A = 25°C, unless otherwise noted.)

Characteristic	Pin	Min	Typ	Max	Unit
Drain Current (No Signal)	4				mA
		Squelch "Off"	2.0	2.8	
		Squelch "On"	3.7	5.2	6.3
Recovered Audio Output Voltage (V _{in} = 10 mVrms)	9	130	170	210	mVrms
Input Limiting Voltage (–3.0 dB Limiting)	16	–	2.6	6.0	μV
Total Harmonic Distortion	9	–	0.86	–	%
Recovered Output Voltage (No Input Signal)	9	60	190	350	mVrms
Drop Voltage AF Gain Loss	9	–3.0	–0.6	–	dB
Detector Output Impedance	–	–	450	–	Ω
Filter Gain (10 kHz) (V _{in} = 0.3 mVrms)	–	40	50	–	dB
Filter Output Voltage	11	0.5	0.7	0.9	Vdc
Mute Function Low	14	–	30	50	Ω
Mute Function High	14	1.0	11	–	MΩ
Scan Function Low (Mute "Off") (V ₁₂ = 1.0 Vdc)	13	–	0	0.4	Vdc
Scan Function High (Mute "On") (V ₁₂ = Gnd)	13	3.0	3.9	–	Vdc
Trigger Hysteresis	–	–	45	100	mV
Mixer Conversion Gain	3	–	28	–	dB
Mixer Input Resistance	16	–	3.3	–	kΩ
Mixer Input Capacitance	16	–	9.0	–	pF

MC3361C

Figure 1. Test Circuit

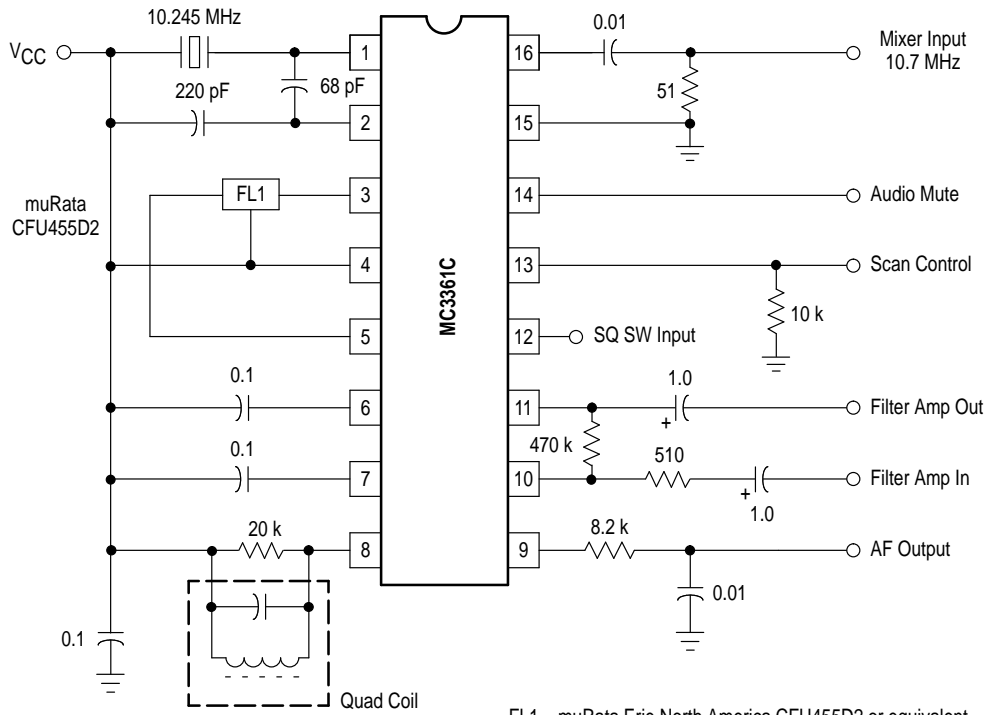

FL1 – muRata Erie North America CFU455D2 or equivalent

Quadrature Coil – Toko America Type 7MC-8128Z or equivalent

C – μ F, unless noted

Figure 2. Audio Output, Distortion versus Supply Voltage

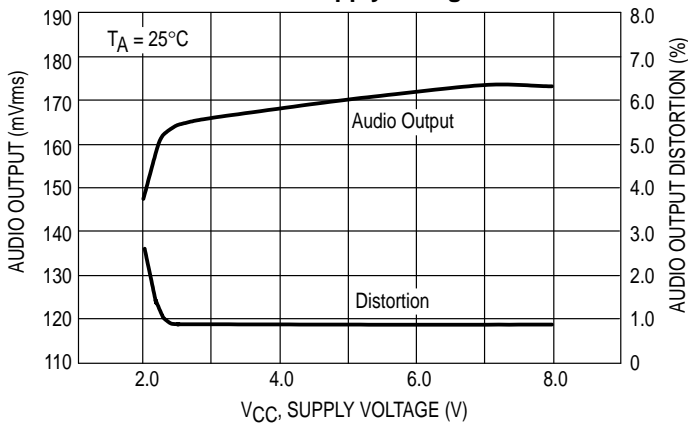

Figure 3. Audio Output, Distortion versus Temperature

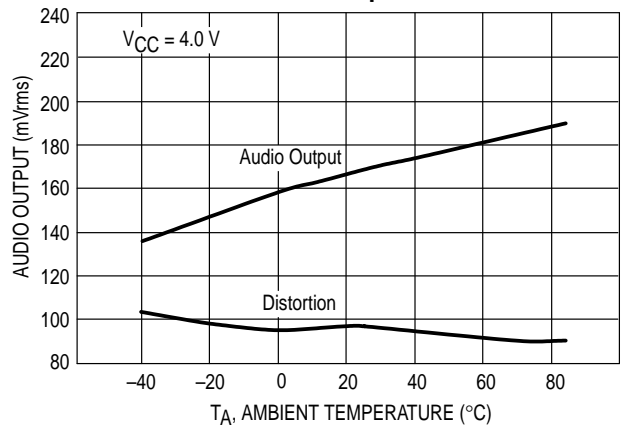

Figure 4. Low Voltage Low Power Narrowband FM IF

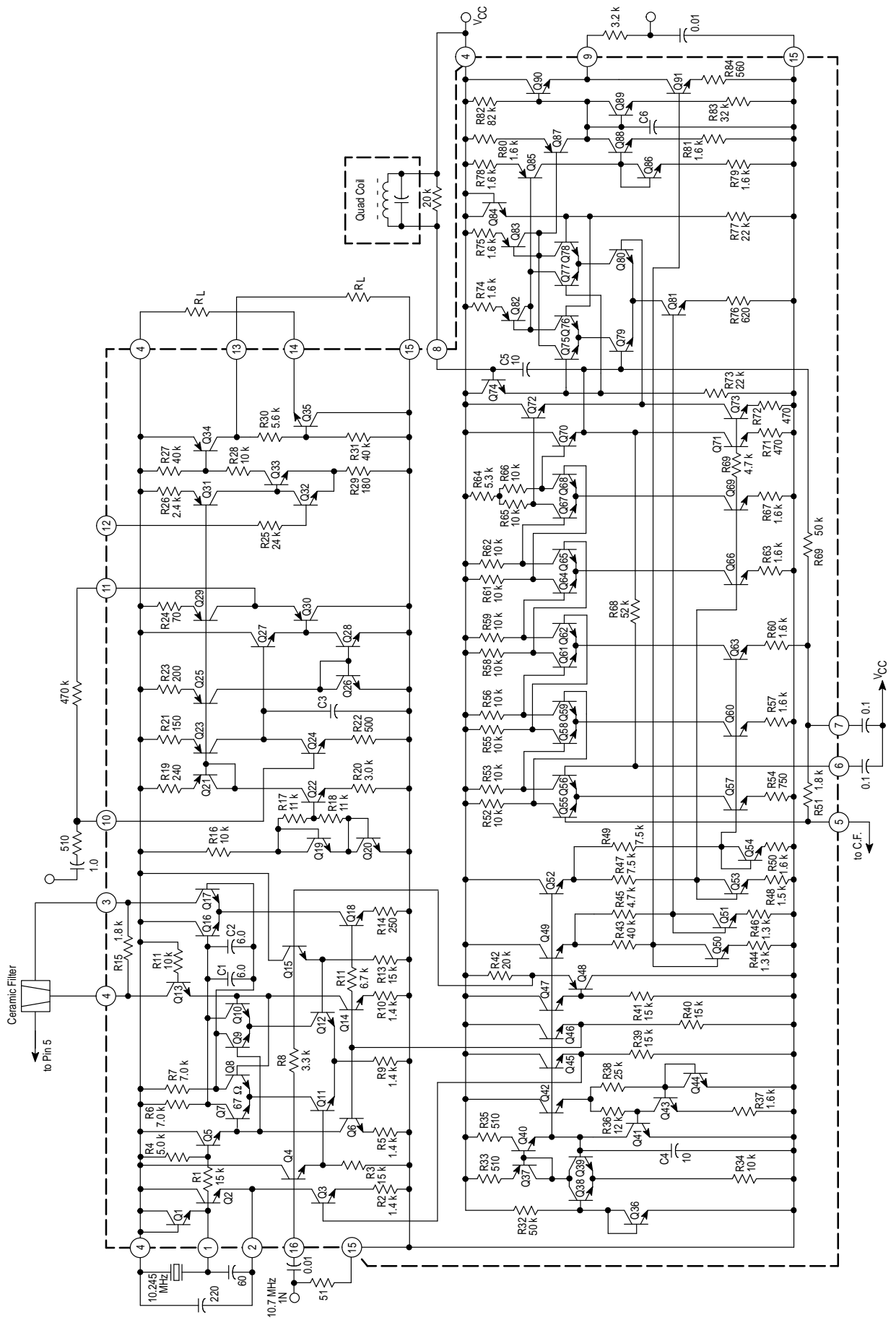

Figure 5. Input Limiting Voltage

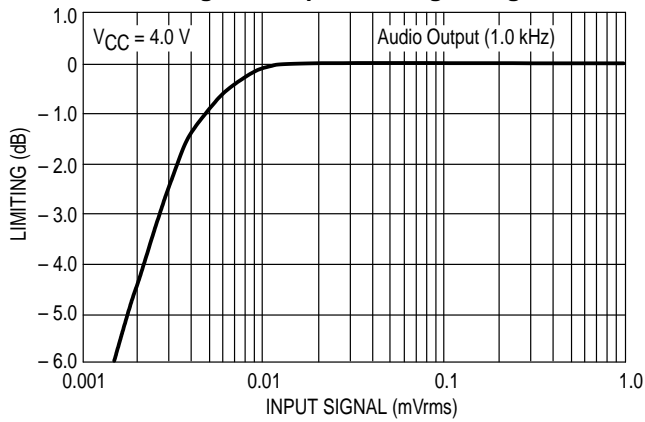

Figure 6. Overall Gain, Noise and AM Rejection

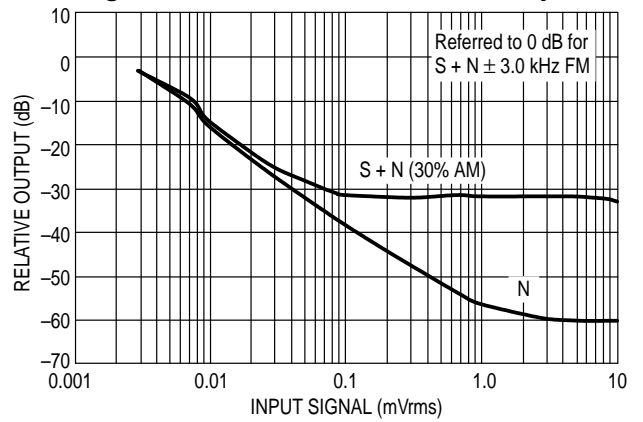

Figure 7. Filter Amp Response

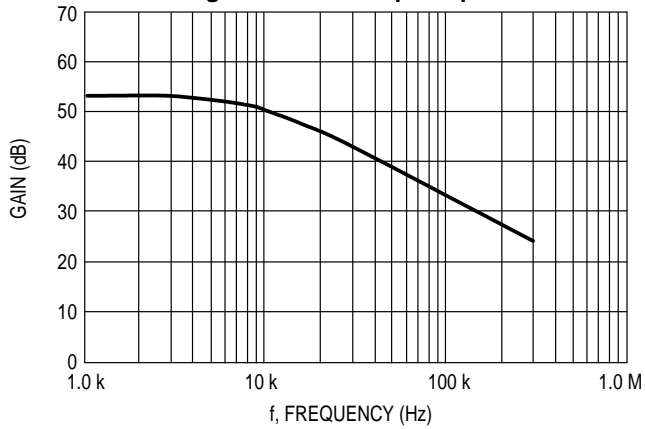

Figure 8. Filter Amp Gain

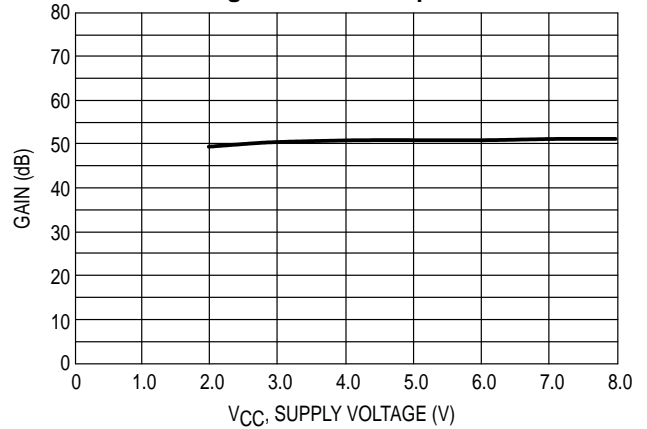
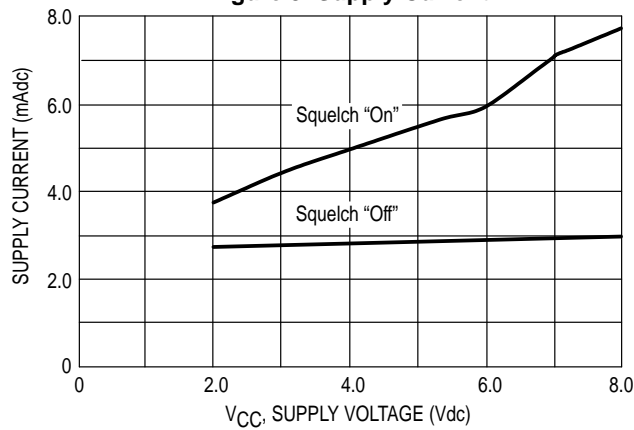
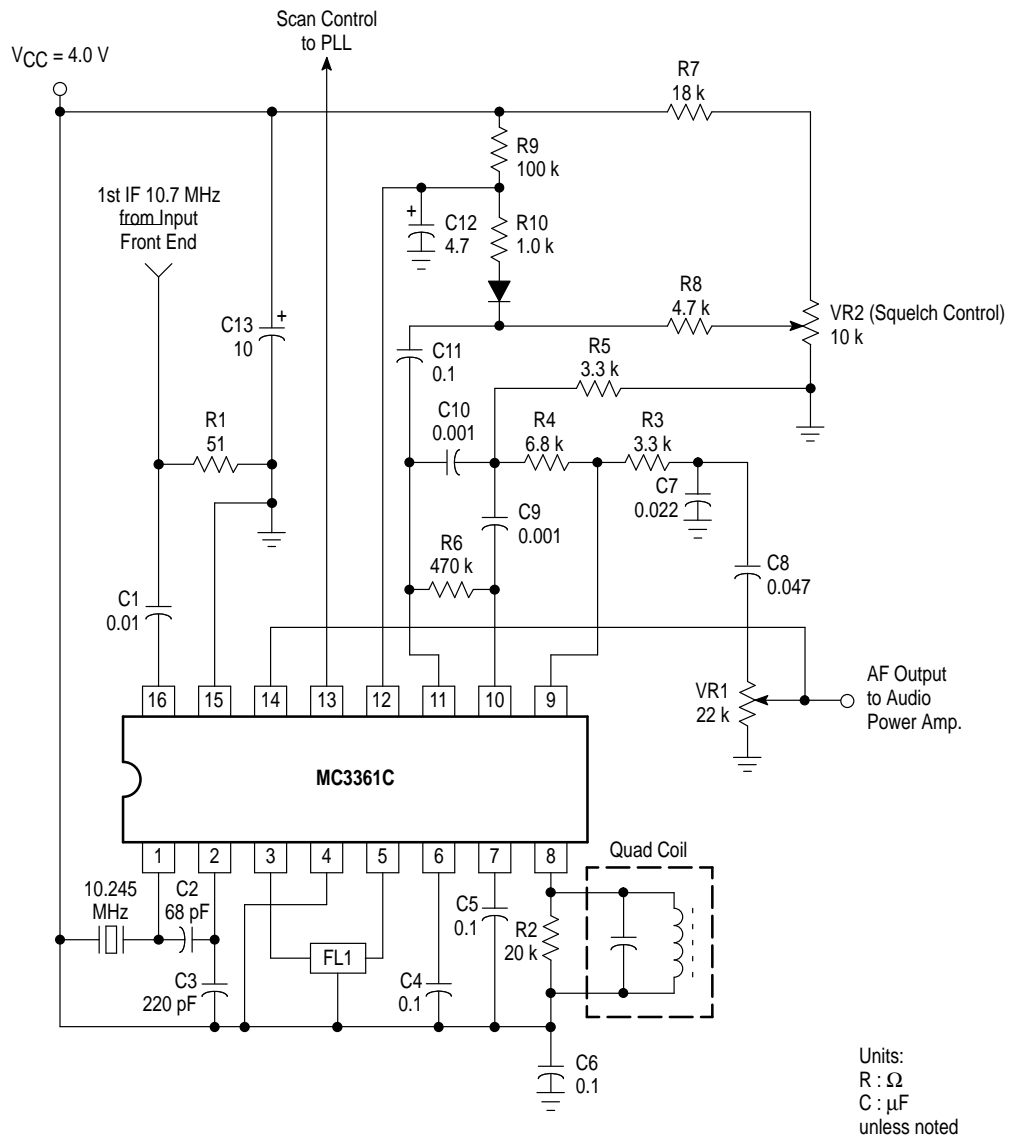

Figure 9. Supply Current



MC3361C

Figure 10. Simplified Application



FL1 – muRata Erie North America Type CFU455D2 or equivalent

Quadrature Coil – Toko America Type 7MC-8128Z or equivalent

MC3361C

OUTLINE DIMENSIONS

P SUFFIX PLASTIC PACKAGE CASE 648-08 ISSUE R

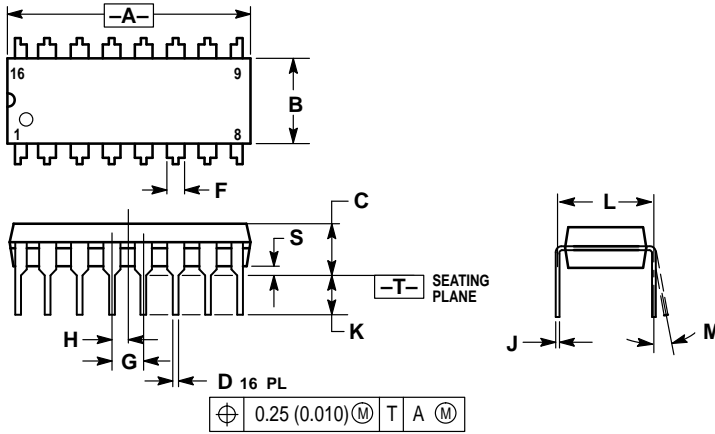

NOTES:

1. DIMENSIONING AND TOLERANCING PER ANSI Y14.5M, 1982.
2. CONTROLLING DIMENSION: INCH.
3. DIMENSION L TO CENTER OF LEADS WHEN FORMED PARALLEL.
4. DIMENSION B DOES NOT INCLUDE MOLD FLASH.
5. ROUNDED CORNERS OPTIONAL.

DIM	INCHES		MILLIMETERS	
	MIN	MAX	MIN	MAX
A	0.740	0.770	18.80	19.55
B	0.250	0.270	6.35	6.85
C	0.145	0.175	3.69	4.44
D	0.015	0.021	0.39	0.53
F	0.040	0.70	1.02	1.77
G	0.100 BSC		2.54 BSC	
H	0.050 BSC		1.27 BSC	
J	0.008	0.015	0.21	0.38
K	0.110	0.130	2.80	3.30
L	0.295	0.305	7.50	7.74
M	0°	10°	0°	10°
S	0.020	0.040	0.51	1.01

D SUFFIX PLASTIC PACKAGE CASE 751B-05 (SO-16) ISSUE J

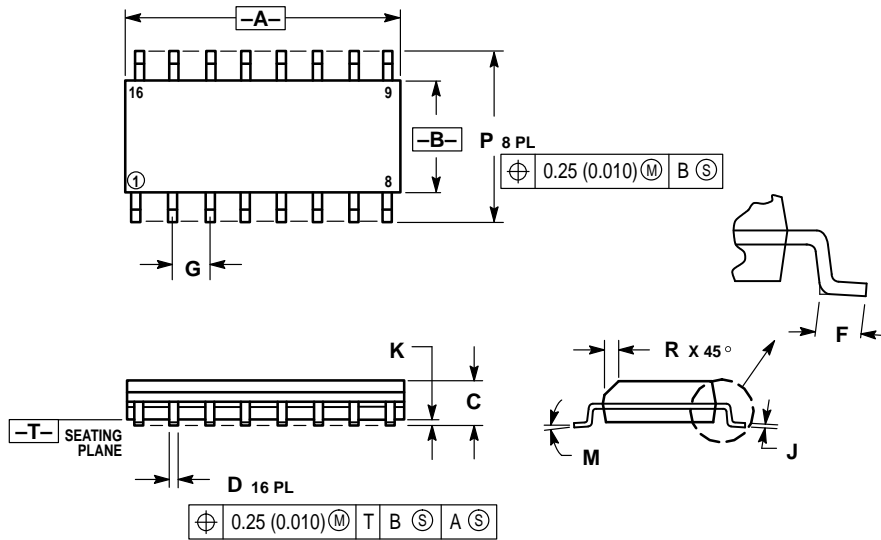

NOTES:

1. DIMENSIONING AND TOLERANCING PER ANSI Y14.5M, 1982.
2. CONTROLLING DIMENSION: MILLIMETER.
3. DIMENSIONS A AND B DO NOT INCLUDE MOLD PROTRUSION.
4. MAXIMUM MOLD PROTRUSION 0.15 (0.006) PER SIDE.
5. DIMENSION D DOES NOT INCLUDE DAMBAR PROTRUSION. ALLOWABLE DAMBAR PROTRUSION SHALL BE 0.127 (0.005) TOTAL IN EXCESS OF THE D DIMENSION AT MAXIMUM MATERIAL CONDITION.

DIM	MILLIMETERS		INCHES	
	MIN	MAX	MIN	MAX
A	9.80	10.00	0.386	0.393
B	3.80	4.00	0.150	0.157
C	1.35	1.75	0.054	0.068
D	0.35	0.49	0.014	0.019
F	0.40	1.25	0.016	0.049
G	1.27 BSC		0.050 BSC	
J	0.19	0.25	0.008	0.009
K	0.10	0.25	0.004	0.009
M	0°	7°	0°	7°
P	5.80	6.20	0.229	0.244
R	0.25	0.50	0.010	0.019

MC3361C

Motorola reserves the right to make changes without further notice to any products herein. Motorola makes no warranty, representation or guarantee regarding the suitability of its products for any particular purpose, nor does Motorola assume any liability arising out of the application or use of any product or circuit, and specifically disclaims any and all liability, including without limitation consequential or incidental damages. "Typical" parameters can and do vary in different applications. All operating parameters, including "Typicals" must be validated for each customer application by customer's technical experts. Motorola does not convey any license under its patent rights nor the rights of others. Motorola products are not designed, intended, or authorized for use as components in systems intended for surgical implant into the body, or other applications intended to support or sustain life, or for any other application in which the failure of the Motorola product could create a situation where personal injury or death may occur. Should Buyer purchase or use Motorola products for any such unintended or unauthorized application, Buyer shall indemnify and hold Motorola and its officers, employees, subsidiaries, affiliates, and distributors harmless against all claims, costs, damages, and expenses, and reasonable attorney fees arising out of, directly or indirectly, any claim of personal injury or death associated with such unintended or unauthorized use, even if such claim alleges that Motorola was negligent regarding the design or manufacture of the part. Motorola and  are registered trademarks of Motorola, Inc. Motorola, Inc. is an Equal Opportunity/Affirmative Action Employer.

How to reach us:

USA / EUROPE: Motorola Literature Distribution;
P.O. Box 20912; Phoenix, Arizona 85036. 1-800-441-2447

JAPAN: Nippon Motorola Ltd.; Tatsumi-SPD-JLDC, Toshikatsu Otsuki,
6F Seibu-Butsuryu-Center, 3-14-2 Tatsumi Koto-Ku, Tokyo 135, Japan. 03-3521-8315

MFAX: RMFAX0@email.sps.mot.com - TOUCHTONE (602) 244-6609
INTERNET: <http://Design-NET.com>

HONG KONG: Motorola Semiconductors H.K. Ltd.; 8B Tai Ping Industrial Park,
51 Ting Kok Road, Tai Po, N.T., Hong Kong. 852-26629298



MC3361C/D

